

 **SWITCHGENIE**
PUMP CONTROLLER



Series 2



Intelligent
Controller



Run dry protection



Instantaneous
digital readout



MADE IN ITALY

Single - Owners Manual

Introduction

PRESENTATION	3
DESCRIPTION	3
HANDLING	3

General use and safety

WARNINGS	4
CAUTION	4
KEYPAD AND LIGHTS INDICATIONS	5
ALARMS	6
TYPICAL INSTALLATIONS	8

Installation

ASSEMBLING	10
OPERATION MENU	11
ELECTRICAL CONNECTIONS	12
ADJUSTMENTS AND SETTINGS (BASIC)	14
ADJUSTMENTS AND SETTINGS (ADVANCED)	16
TRIMMER SETTINGS	33
CONTACT ALARM OUTPUTS	33

Maintenance

PUMPS STOP SERVICE	34
SPARE PARTS	34
WASTE DISPOSAL	34
NOTES	35
WARRANTY	36

Certifications

CERTIFICATE OF CONFORMITY	39
---------------------------	----

PRESENTATION

The purpose of this manual is to provide the necessary information for the proper installation, use and maintenance of SwitchGenie Single. The user should read this manual before operating the unit. Improper use may cause damage to the machine and lead to the forfeiture of the warranty coverage. Always specify the model identification code when requesting technical information.

DESCRIPTION

These control panels are designed for controlling 1 motor or electric pump used in pressurization systems or in applications for emptying wells or water tanks..

Argon Distributors shall not be liable for any damage caused or suffered by the unit as a result of its unauthorised or improper use.

TECHNICAL FEATURES

Self learning of the motor data; min-max amperage protection (A); dry running protection using $\cos \Phi$ and min current; min and max voltage protection (V); phase failure protection; start and stop delay; delay network restore, protection delay, frequency 50-60Hz.

HANDLING

The control panel must be handled with care, as falls and knocks can cause damage without any visible external signs.

PRELIMINARY INSPECTION

After you have removed the external packaging, visually inspect the control panel to make sure it has suffered no damage during shipping.

If any damage is visible, inform your supplier as soon as possible, no later than five days from the delivery date.

Our units must be installed in sheltered, well-ventilated, non-hazardous environments and must be used at a maximum temperature of +40°C and minimum of -5°C.

- Panel alarm LED
- 12V DC output for buzzer
- Alarm output relay 12VDC or NO contact
- Alarm output relay 230V or 400V
- Min/max voltage, current, frequency
- Phase failure
- Min COS FI
- Motor Klixon
- Water in oil chamber

STORING

If for any reason the unit is not installed after it has reached its destination it must be stored properly.

The external packaging and the separately packed accessories must remain intact, and must be protected from the weather, especially from freezing temperatures, and from any knocks or falls.

WARNINGS



RISK OF ELECTRIC SHOCK

Failure to follow the instructions in this manual, carries a risk of electric shock.



RISK FOR PEOPLE AND PROPERTY

Failure to follow the prescriptions in this manual, carries a risk of damage to persons and/or property.



WARNING

Failure to observe the prescriptions in this manual, cause damage to the pump, the unit or the system.

CAUTION



ATTENTION: PUMPS

- Make sure the pumps are fully primed before you start it.
 - Make sure the pumps are running with the correct rotation.
 - The electric pumps or the motors can start up automatically.
-



ATTENTION: ELECTRICAL CONNECTION

- The control panel must be connected by a qualified electrician in compliance with the electrical regulations in force.
 - The electric pumps or the motors and the panel must be connected to an efficient grounding system in compliance with the electrical regulations locally in force.
 - Ground the unit before carrying out any other operation.
-



ATTENTION: SERVICE

As a general rule, always disconnect the power supply before proceeding to carry out any operation on the electrical or mechanical components of the unit or system.

KEYPAD AND LIGHTS INDICATIONS

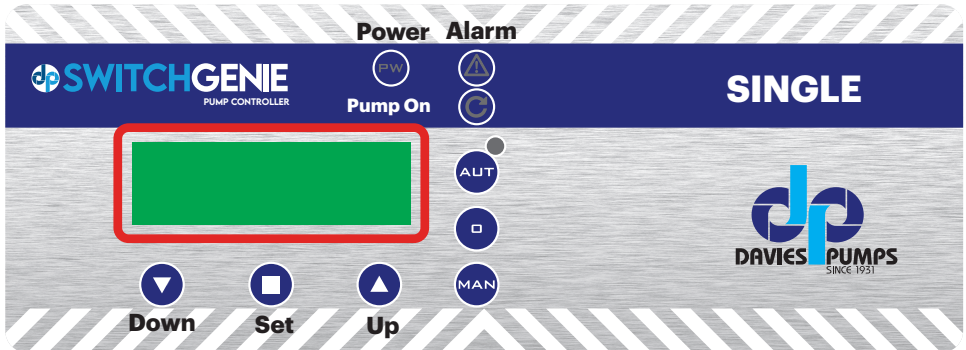

CONTROL PANEL



PW

blue light indicates the panel is connected to power and is live.



ALARM

red light to indicate a general alarm and pump stop. (min/max Amp, min/max V, min/max level, motor klixon, water in oil chamber, phase failure).



START

green light to indicate pump start; fixed on to indicate pump running, flashing to indicate auto-setting mode.



AUT

the button activates the auto-setting mode and automatic pump operation (if the green light is on, the automatic mode is active).



O

pump stop button and reset alarms, sound alarm output turn-off.













MAN

activation of pump manually; holding it down, the motor is operated in by-pass mode, with all protections bypassed.

ALARMS

The control panel signals a series of alarms that may occur during operation. Some of these stop the pumps, while others are only displayed.

All alarms are displayed on the panel (red LED flashing), while the display shows the code/alarms occurred until the cancellation by the operator.

ALARM CODE	ALARM DESCRIPTION	PUMP STOP	RELAY ON	LED SIGNAL
AL 1	MIN VOLTAGE	YES	YES	
AL 2	MAX VOLTAGE	YES	YES	
AL 3	LOW FREQUENCY	NO	YES	
AL 4	HIGH FREQUENCY	NO	YES	
AL 5	DRY RUNNING P1	YES	YES	
AL 6	MAX AMPERAGE P1	YES	YES	
AL 7	MAX STAR PER HOUR	NO	YES	
AL 8	WATER IN OIL CHAMBER P1	NO	YES	
AL 9	KLIXON P1	YES	YES	
AL 10	MIN LEVEL	YES	YES	
AL 11	MAX LEVEL	NO	YES	

* Phase failure will cause the pump and panel to shut down. Operation will be restored when power supply is correct.



The alarm “AL 11” will attempt to start the pump without other signal inputs

ALARM WITH STOP PUMP



Following the detection of an alarm and the consequent blocking of the pump, the control panel provides the following operations:

- Try the first restart after 5 min.
- In case of a negative result, make another attempt after 30 min. and 3 other attempts with intervals of 60 min.
- After 5 attempts if the alarm persists, the control panel permanently blocks the pump and the alarm remains active until the user intervenes.

DELETE ALARM

P1



To delete an alarm (for example dry run), press the pump (P1) button "O" as follows:

- the first press of the "O" button removes only the voltage from the buzzer terminals ("mute" function)
- the second press of the "O" button reset the alarm.

If the alarm is not reset (by pressing the "O" key twice), at the next alarm signal, the panel will remain in "mute" mode.



IMPORTANT!

If after having canceled an alarm, the same alarm occurs again, it is recommended to locate the cause of the failure before starting again.

TYPICAL INSTALLATIONS

Picture 1

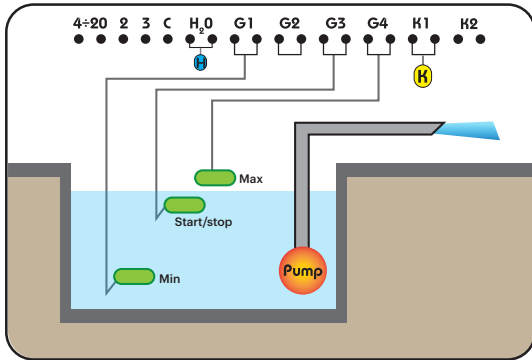

Picture 2

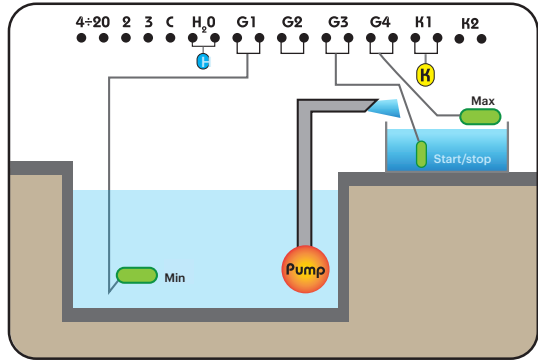

Picture 3

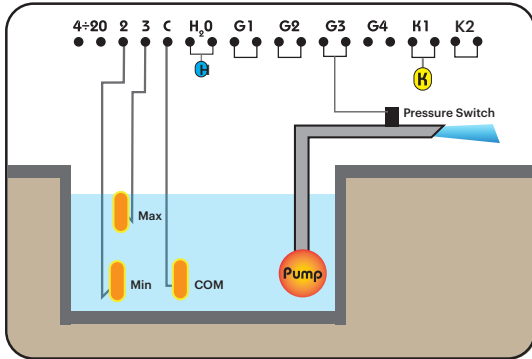

Picture 4

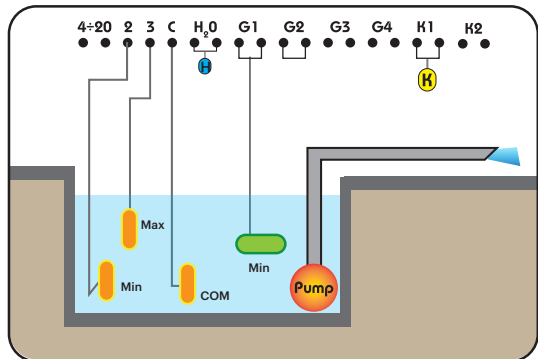

KEY

 Clear water float

 Pressure Switch

 Water in seal chamber

 Pump

 4÷20 pressure transducer

 Waste water float

 4÷20 Piezoresistive Sensor

 Level Probe

 Klixon

TYPICAL INSTALLATIONS

Picture 5

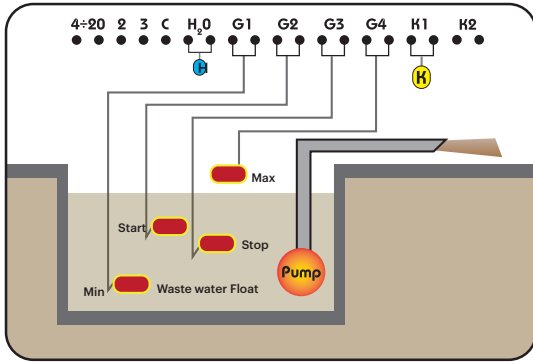

Picture 6

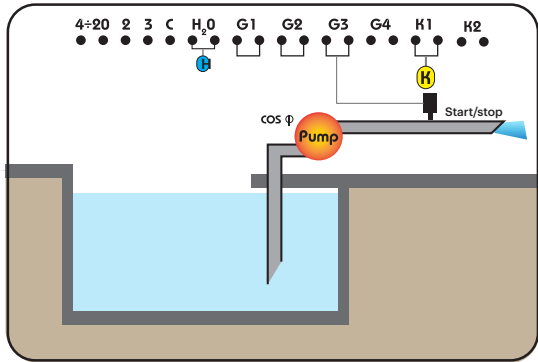



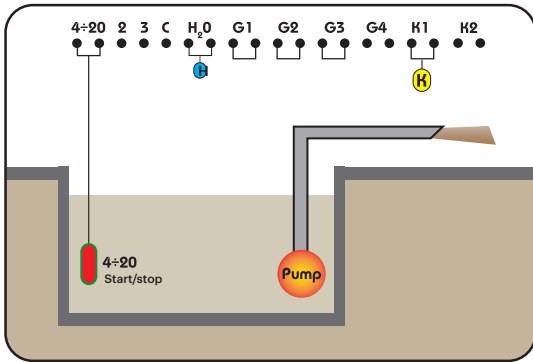



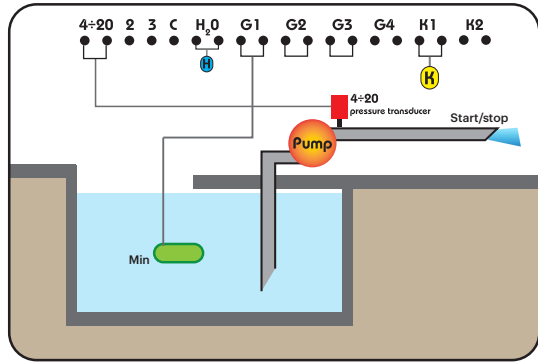

Picture 7



Picture 8



KEY

- | | | |
|---|--|---|
|  Clear water float |  Pressure Switch |  Water in seal chamber |
|  Pump |  4÷20 pressure transducer | |
|  Waste water float |  4÷20 Piezoresistive Sensor | |
|  Level Probe |  Klixon | |

ASSEMBLING

Fix the control panel to a stable support with screws and screw anchor using the holes arranged in the box (pic. 1).

To fix the cables in their terminals use a tool of the proper size to avoid damaging screws.

If use an electric screwdriver pay attention not to damage the thread or the screws.

After installing, remove all plastic or metallic surplus (ex. Pieces of copper of the cables or plastic shavings of the box) inside the box before supplying power.

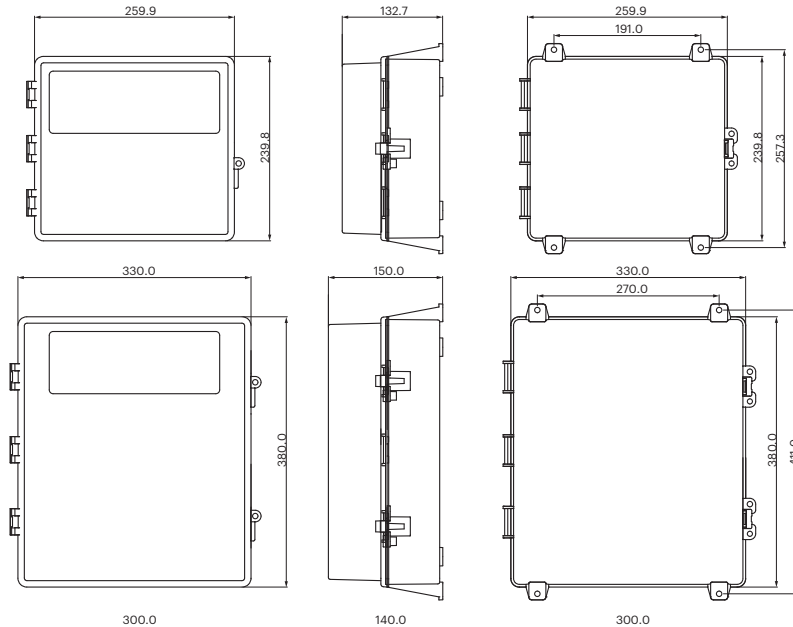

fig. 1

LINE OF SUPPLY CURRENT

Connect the unit at ground before carrying out any other operation.

The voltage input corresponds to the data written on the panel and on the pump:

- (400V ± 10% 50/60Hz x il SWITCHGENIE -400/...)
- (230V ± 10% 50/60Hz x il SWITCHGENIE -230)

LINE OF MOTOR POWER SUPPLY

Connect the unit at ground before carrying out any other operation.

The voltage input corresponds to the data written on the motor:

- (400V±10% 50/60Hz three-phase)
- (230V±10% 50/60Hz single-phase)

Make sure that the power-supply-cable can bear the nominal current and connect it to the terminals of the general switch of the control panel.

If the cables are exposed, they must be appropriately protected.

The line must be protected with an Earth Leakage and magnetic switch measured in accordance with the regulations locally in force.

When starting, make sure that the motor respects the right direction of rotation for the pump usually indicated by an arrow printed on the motor.

OPERATION MENU

The Switchgenie control panels have a simple configuration menu which allows a wide range of settings and options to be easily set up to control and protect a pump system.

The main LCD screen has three views which can be changed using the up/down arrows to view operating data. Main view shows current power supply voltage and Hz with operating mode and type, this will also display alarm code in case of a failure. Second screen shows live motor current and timer values if active. Third screen is active if using a 4-20mA sensor and shows current pressure value.

There is an initial quick start configuration and an advanced configuration menu which are set using the buttons and LCD screen to set.

Basic Quick Start Menu:

This menu is accessible when the panel is connected to the power supply for the first time and allows basic configuration and self learning of pump data (without accessing advanced menu) for quick set up and operation. All electrical and hydraulic connections must be complete and pump system primed for operation.

Advanced Menu:

The advanced menu can only be accessed when internal dip switch 2 is set to ON position. When settings are complete, return switch to OFF position to prevent unauthorised changes to parameters from the control panel external buttons.

The seven advanced levels can be viewed using the up/down arrows to scroll through the levels. Each level can be entered using the confirm button and then the up/down arrows to scroll through the parameters.

Each parameter can be altered by pressing the confirm button, then use the up/down arrows to select a value and press confirm to set.

Use the up/down arrows and confirm button to work back and exit the menu.

- **M01** Utility: Language/Start Delay/Manual Button/Max Level Alarm Delay
- **M02** General: Start Delay/Stop Delay
- **M03** Net Control: Nom Voltage/Min Voltage/Max Voltage/Nom Frequency/Frequency Range
- **M04** Pump 1: Autotuning/Nom Current/Min Amperage/Max Amperage/Starts Per Hour/Min Cos.
- **M05** –
- **M06** Program: Operation/Type/Self Holding/BMS
- **M07** Sensor: Parameters/Full Scale/Min Level/Max Level/Start P1-Stop P1
- **M08** Timer: Engage Timer/Timer T1 On/Timer T1 Off
- **Exit**

See the following step by step instructions for details on how to complete quick start and advanced menu configurations.

Pressing and holding the up or down arrows allows the user to quickly change the required value.

ELECTRICAL CONNECTIONS

SwitchGenie 230V

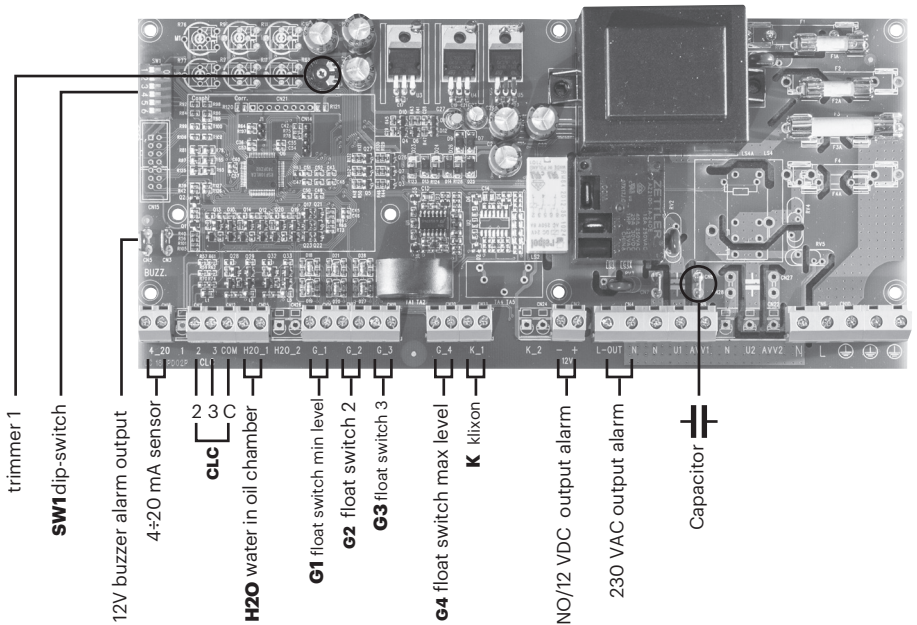
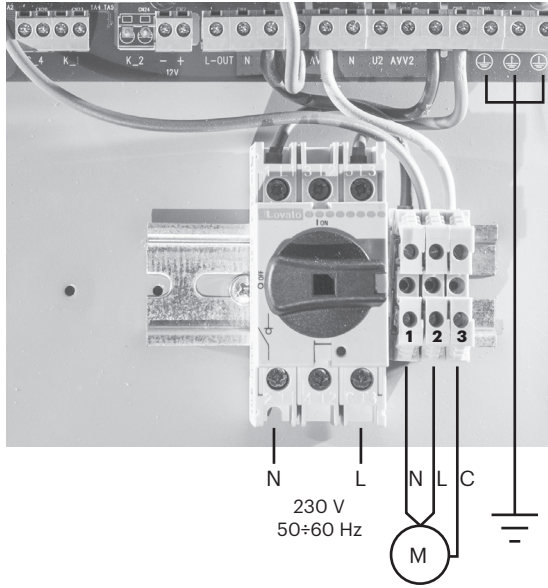

SwitchGenie 400V

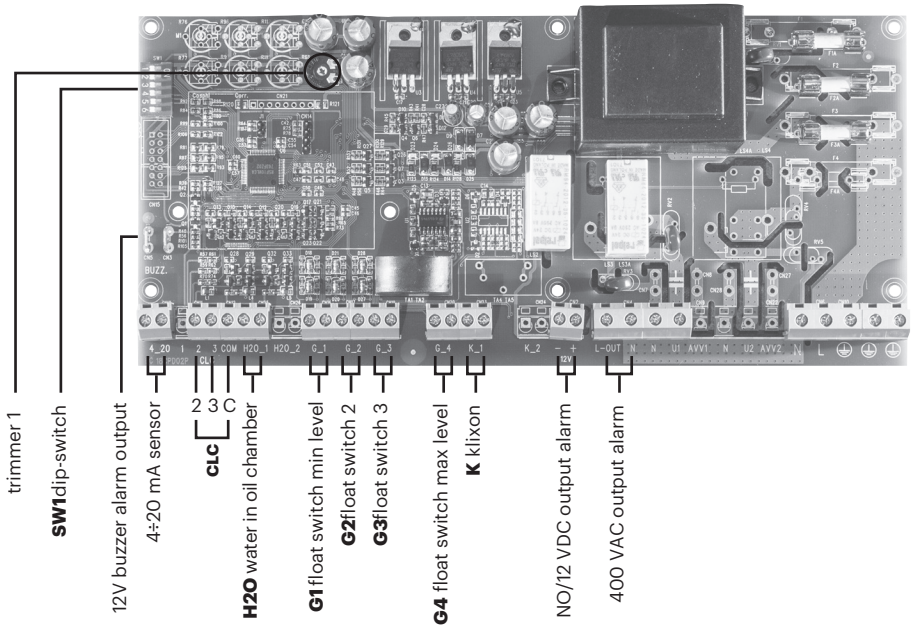
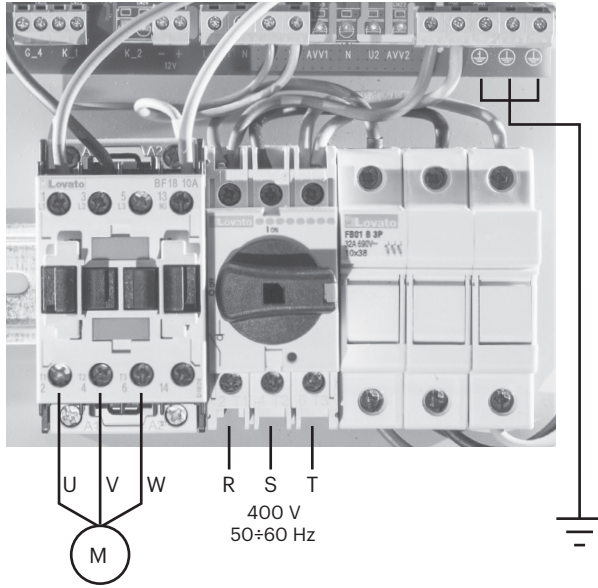

BASIC QUICK START MENU

CONTROL PANEL TURN ON



After making all the electrical connections, switch on the control panel and wait for the initial message to appear on the display.

LANGUAGE SETTING (OBLIGATORY)



Select the display language by scrolling the menu with the appropriate arrows (step 1 and 2).

When completed, press the confirm button (step 3) to continue.

PUMP TRIGGER

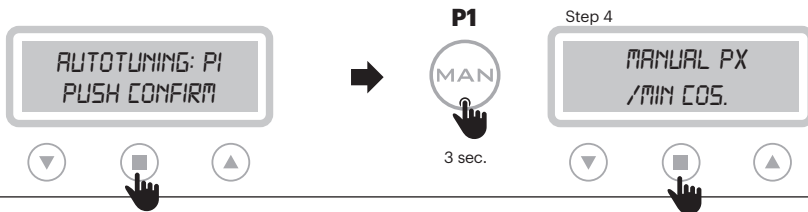

To proceed with self-learning, the pumps must first be activated.

Do not press Confirm: First manually start and run the pump by pressing and holding the "MAN" button for 3 seconds.

Press confirm to go to Auto-tuning

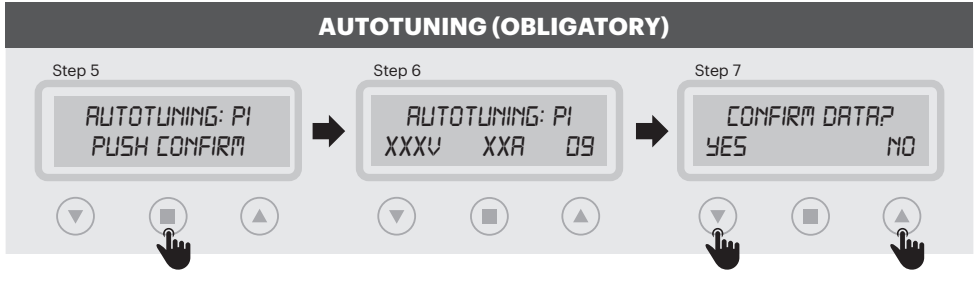

To start the self-learning of the pump data, press confirm and the pump will run for 10 seconds to learn operating data. (step 5).

For the final confirmation of the data (step 7) type "YES", or enter "NO" to go back (to step 5).



Before starting the self-learning procedure, it is necessary to check with a tester that the mains voltage corresponds to the nominal one or at least to the mains voltage.



IMPORTANT!

After pressing the final confirmation button, self-learning is no longer possible from basic menu.

To perform the self-learning again it is necessary to access the advanced menu MO4

CONTROL PANEL OPERATIVITY



Once the self-learning phase is completed, the panel screen displays the data learned.

By pressing the "AUT" button the panel becomes operational.

PRESET PARAMETERS	
LANGUAGE: selected	STOP DELAY: 1 sec.
TURN ON DELAY: 2 sec.	OPERATION: emptying
MANUAL KEY: unstable	TYPE: potable
START DELAY: 4 sec.	SELF HOLDING: on

To change any of these settings, access the advanced menu.

ADJUSTMENTS AND SETTINGS (ADVANCED MENU)

ACCESS TO ADVANCED MENU

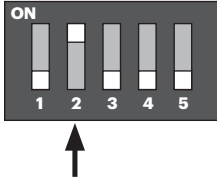

DIP-SWITCH 2

The control panel is set as standard with the dip-switch 2 in the “OFF” position. To access the “ADVANCED MENU” and modify the various parameters, **switch off the control panel and set dip-switch 2 to “ON”**. Then turn the control panel back on to display. the “ADVANCED MENU” will be on the screen.

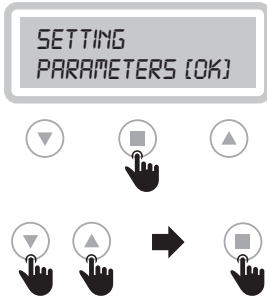

SETTING PARAMETERS

To access the advanced menu and set the various parameters, press confirm. On the display will appear in cascade all the functions. To enter each individual function, select it with the arrows and enter the confirmation button.

EXIT
MO1 UTILITY
MO2 GENERAL
MO3 NET CONTROL
MO4 PUMP 1

MO6 PROGRAM
MO7 SENSOR
MO8 TIMER
EXIT

CONFIRM MODIFICATIONS AND EXIT FROM ADVANCED MENU (EXAMPLE)

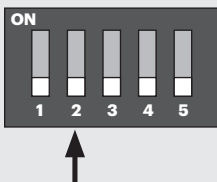
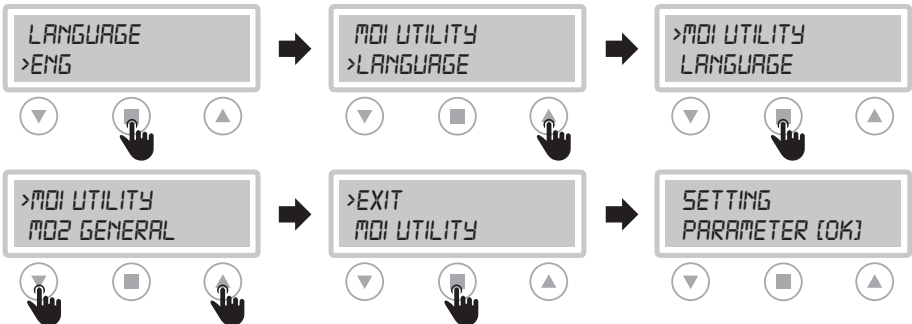

DIP-SWITCH 2

Once the setting of the various parameters has been confirmed (for example the LANGUAGE parameter), to exit the “ADVANCED MENU” **bring the dip-switch 2 back to the “OFF” position**.

MO1 UTILITY

ACCESS TO FUNCTION	MODIFIED PARAMETERS
 <p>>MO1 UTILITY MO2 GENERAL</p> <p>Navigation icons: Down, Enter, Up</p>	<p>LANGUAGE (default: as selected) Language selection</p> <p>START DELAY (default: 2 sec.) Control panel switch-on delay after restart (in sec.)</p> <p>MANUAL KEYPAD (default: OFF) Possibility of operating the "MAN" button in stable or unstable mode (ON: stable / OFF: unstable)</p> <p>MAX LEVEL ALARM DELAY (default: OFF) Possibility to delay 15 minutes. (not modifiable) the maximum level alarm. The display will show the alarm and the pump will start (if available), only the alarm relay and the buzzer will be delayed.</p>

CHANGE LANGUAGE

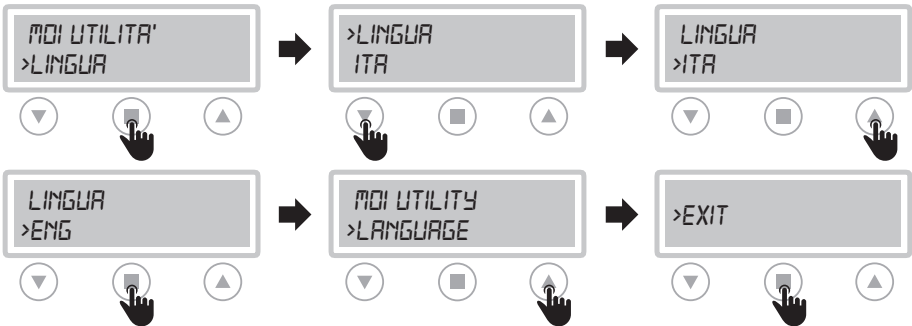

CHANGE START DELAY

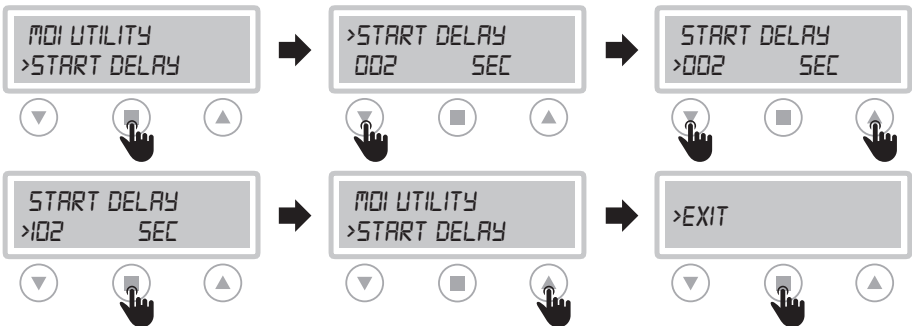

CHANGE "MAN" BUTTON (STABLE/UNSTABLE)

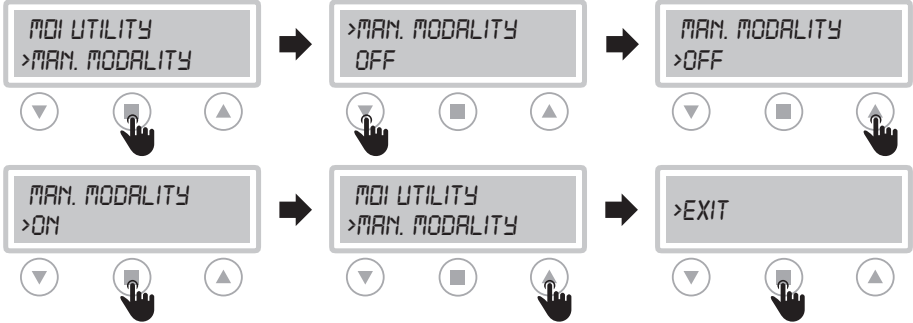

CHANGE MAX LEVEL ALARM DELAY

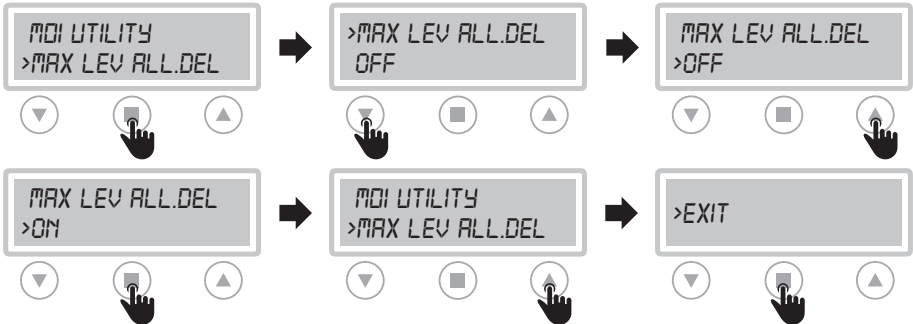

M02 GENERAL

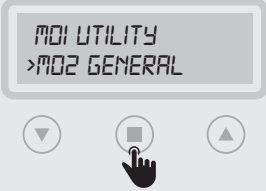
ACCESS TO FUNCTION	MODIFIED PARAMETERS
	<p>PUMP START DELAY (0-99 sec. Default 4s.) PUMP STOP DELAY (0-99 sec. Default 1s.)</p>

CHANGE START DELAY

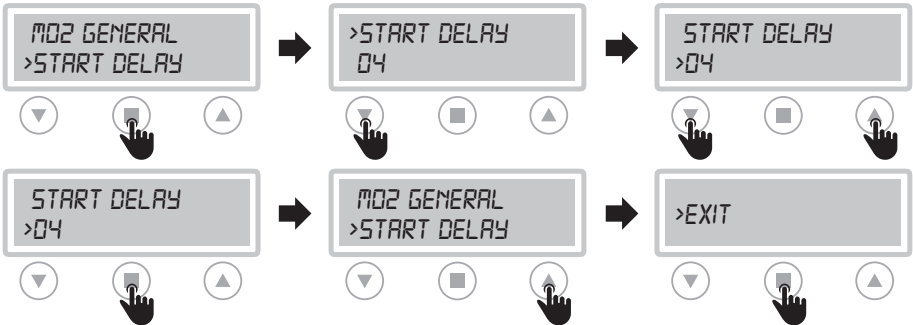

CHANGE STOP DELAY

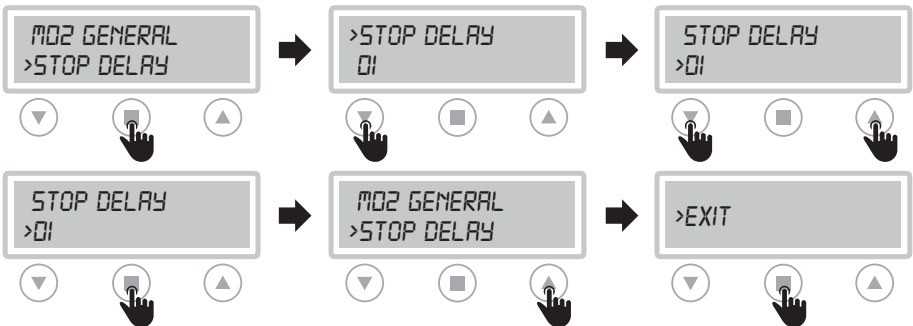

M03 NET CONTROL

ACCESS TO FUNCTION	MODIFIED PARAMETERS
 <p>M02 GENERAL >M03 NET CONTROL</p> <p>Navigation: Down arrow, Enter key, Up arrow</p>	<p>NOMINAL VOLTAGE (0-450V) Default Set by Auto-tuning.</p> <p>MINIMUM VOLTAGE (1-100%) Default 90%</p> <p>MAXIMUM VOLTAGE (1-100%) Default 90%</p> <p>NOMINAL FREQUENCY (50/60Hz) Default set by Auto-tuning.</p> <p>FREQUENCY RANGE (0-10%) Default 10%</p>

CHANGE NOMINAL VOLTAGE

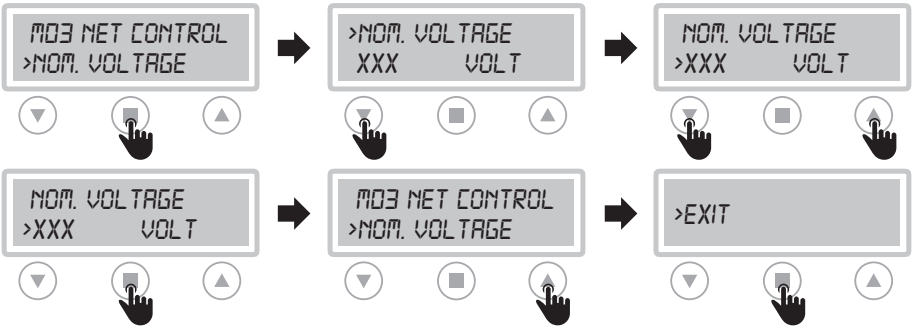

CHANGE MINIMUM VOLTAGE

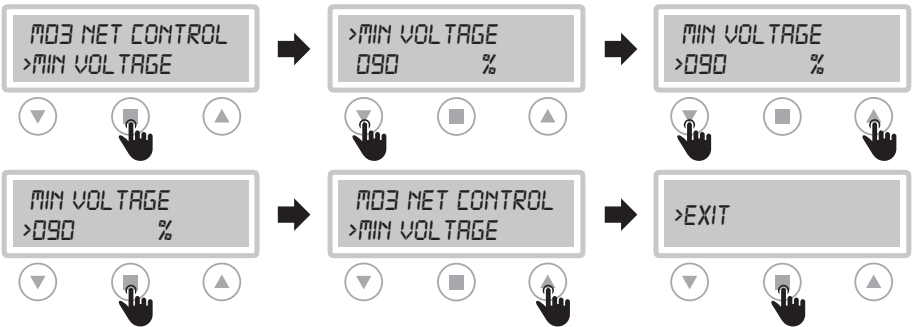

CHANGE MAXIMUM VOLTAGE

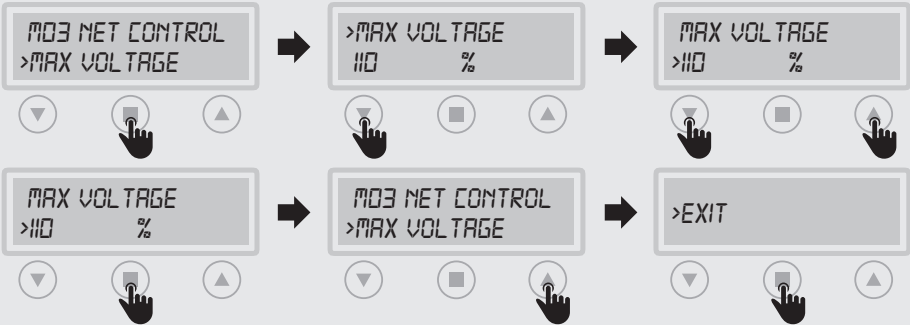

CHANGE NOMINAL FREQUENCY

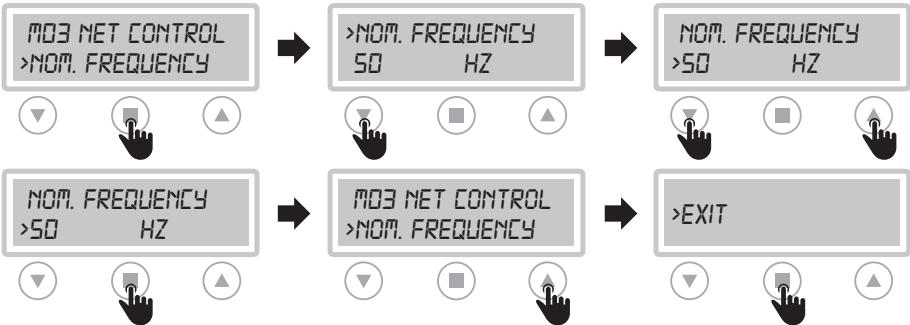

CHANGE FREQUENCY RANGE

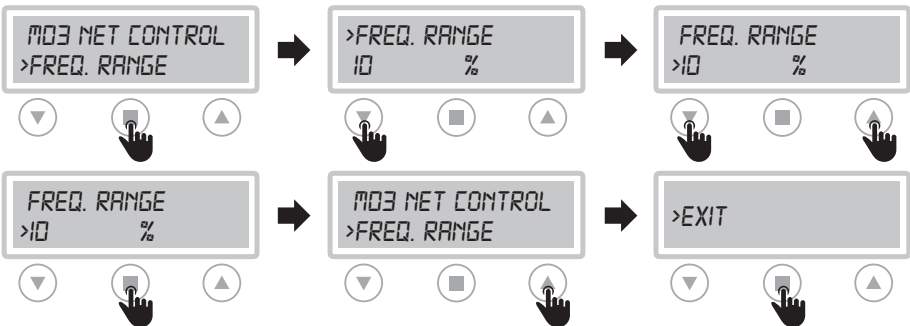

MO4 PUMP 1

ACCESS TO FUNCTION

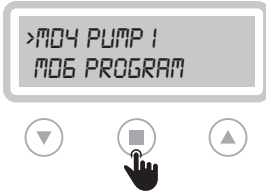

The amperage value and $\cos\phi$ shown on the display may differ $\pm 5\%$ from the nominal value of the pump (nameplate data) since the control panel is not a measuring instrument. The same value may differ depending on the operating conditions of the installation.

MODIFIED PARAMETERS

AUTOTUNING

It allows the self-learning of the data to be carried out again

NOMINAL CURRENT (0-999A) Default set by Auto-tuning.

MINIMUM AMPERAGE (1-140%) Default 85%.

MAXIMUM AMPERAGE (1-140%) Default 130%

Max current setting for overcurrent protection

START PER HOUR (1-99) Default 30.

Set max number of pump starts per hour

MIN $\cos\phi$ (default: 75% of value read in autotuning)

Set min. $\cos\phi$ for dry running protection

AUTOTUNING

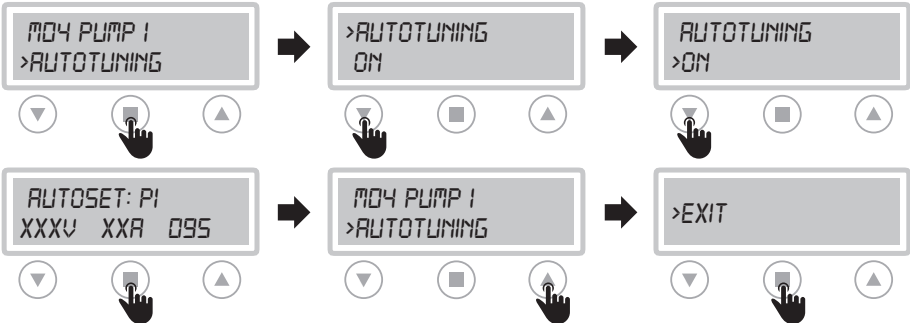

CHANGE NOMINAL CURRENT

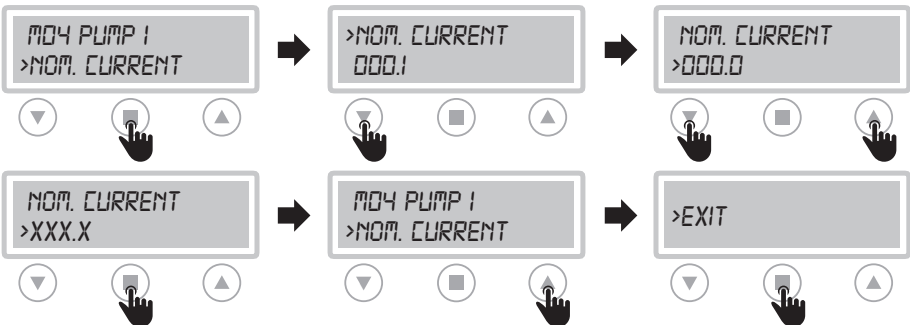

CHANGE MINIMUM AMPERAGE

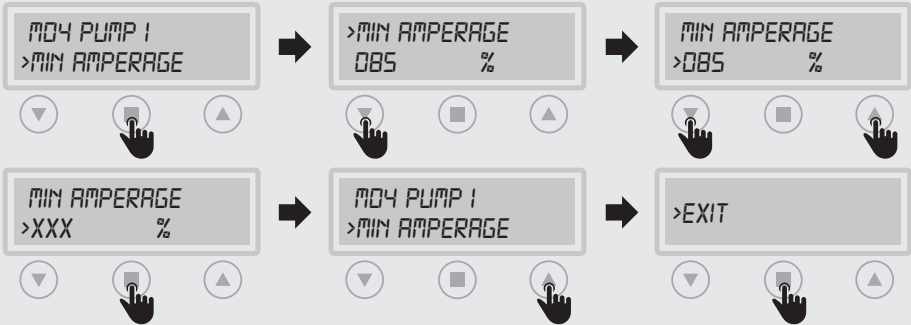

CHANGE MAXIMUM AMPERAGE

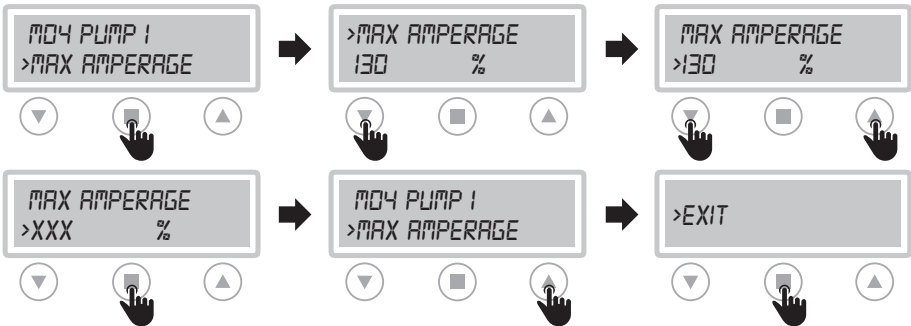

CHANGE START PER HOUR

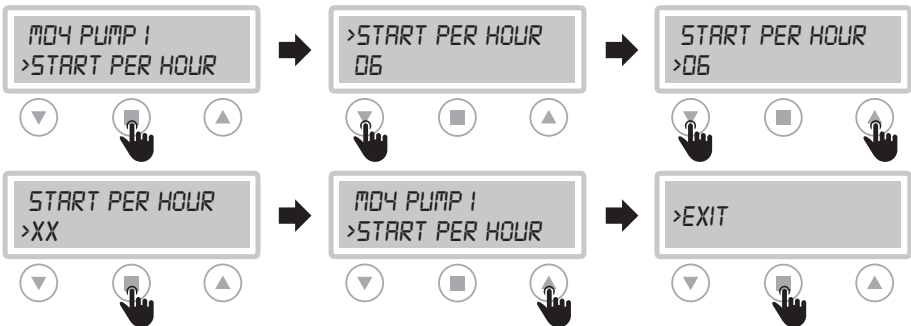

CHANGE MIN COS ϕ

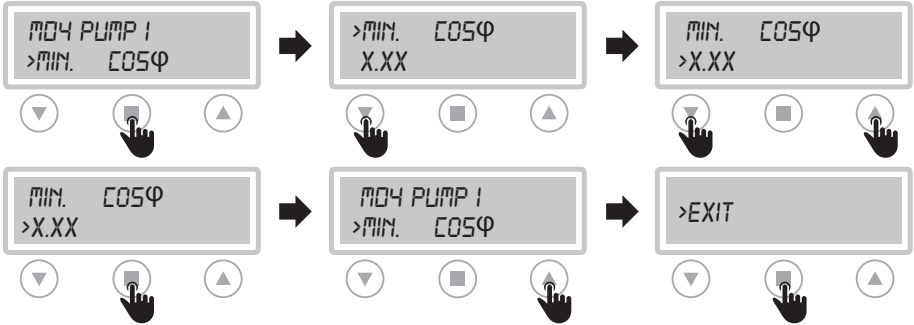

M06 PROGRAM

ACCESS TO FUNCTION

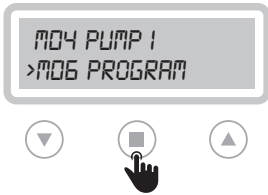

SELF HOLDING OPERATION
If the self holding is ON and the water level is going up, G1 is up, G2 goes up and starts pump 1. If the water level is going down, G2 goes down but it does not stop pump 1, G1 goes down and stops the pump.

MODIFIED PARAMETERS

OPERATION CONTROL (Default 'Empty')

For tank emptying select "EMPTY" or filling select "FILL" to set float switch operation

TYPE

Selection of clear or dirty water types for level float switch configuration.

For 'Waste Water' type, only empty function is available.

SELF HOLDING

Mostly used for waste water applications: 4 float switches being used (G1 stop the pump, G2 start pump 1, G4 max level alarm and start the pump)

BMS (remote emergency Start/stop)

To start/stop the control panel by remote button, the use of the 'BMS' function takes place through the G4 input.

(contact closed: pump enabled. Open contact: pump disabled)

OPERATION (EMPTY/FILL)

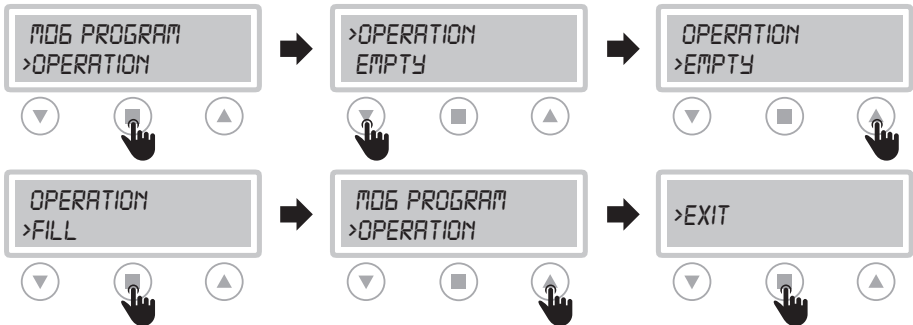

TYPE (POTABLE/WASTE WATER)

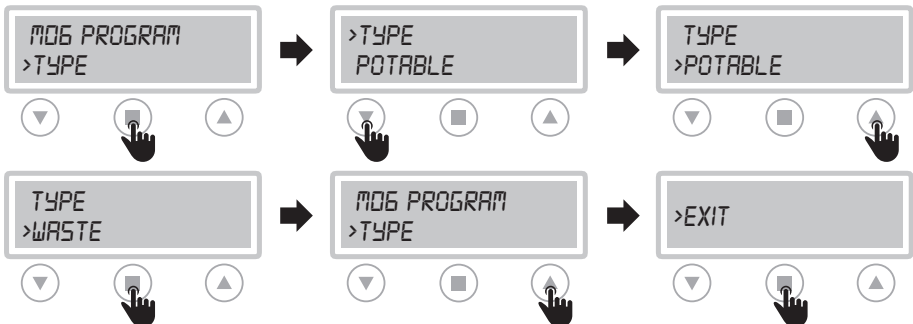

SELF HOLDING

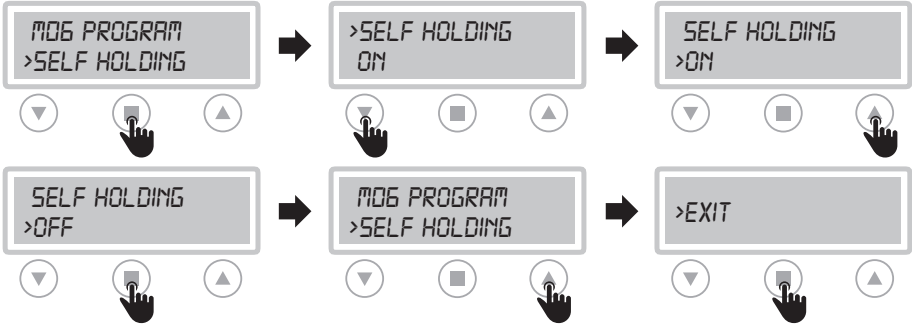

BMS SETTING

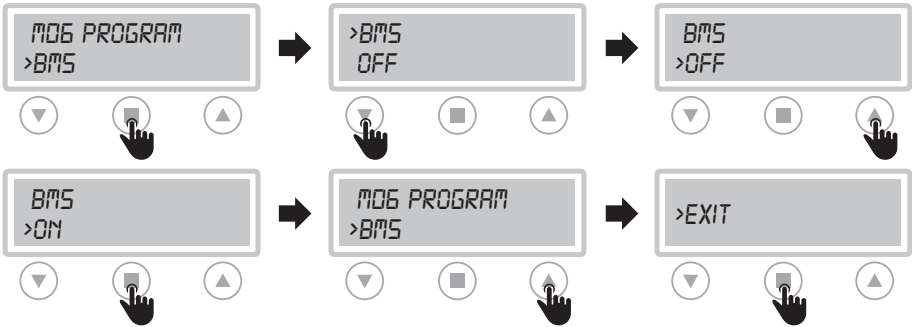

M07 SENSOR (sensor/transducer 4÷20 mA)

ACCESS TO FUNCTION



The "SENSOR" function allows to use the control panel with piezoresistive, piezocapacitive level sensors or pressure transducers (logic 4÷20 mA).

ATTENTION: Switch off the control panel before connecting the sensor.
Check correct orientation of transducer leads

MODIFIED PARAMETERS

PARAMETERS (Default off)

Setting unit of measure (mt/bar/celsius). Use bar for pressure transducers and mt for piezoresistive sensors.

FULL SCALE

Set the full scale value specified by the manufacturer of the sensor used (default value 160.0mt)
0-10 bar transducer = 010.0

MINIMUM LEVEL (Default 5.0)

Parameter active only with unit of measure in mt

MAXIMUM LEVEL (Default 100)

Parameter active only with unit of measure in mt

Start P1/Stop P1. Default is 10.0 - 20.0

SET PARAMETERS

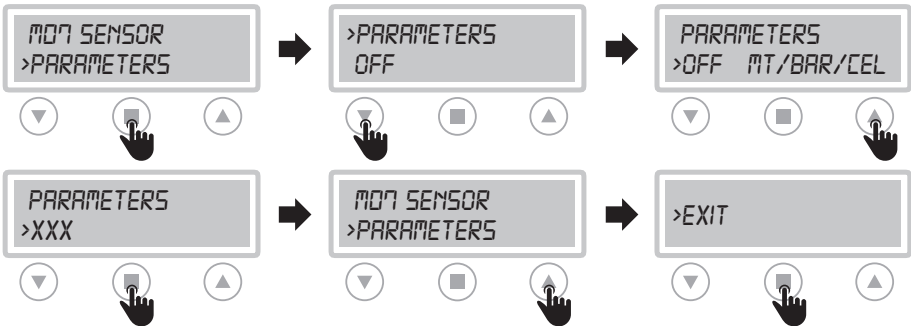

SET FULL SCALE

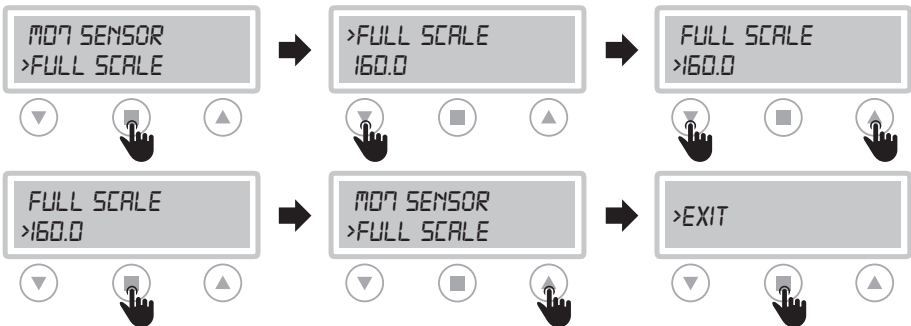

SET MINIMUM LEVEL

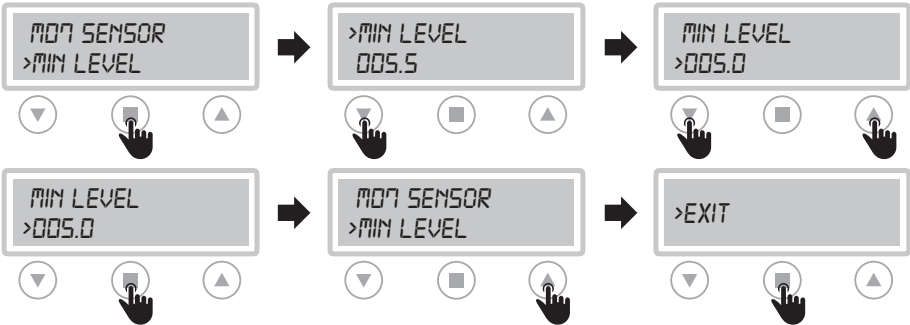

SET MAXIMUM LEVEL

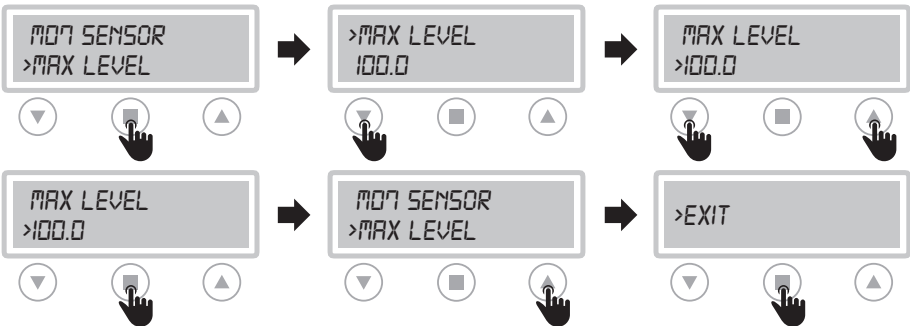

PUMP 1 START

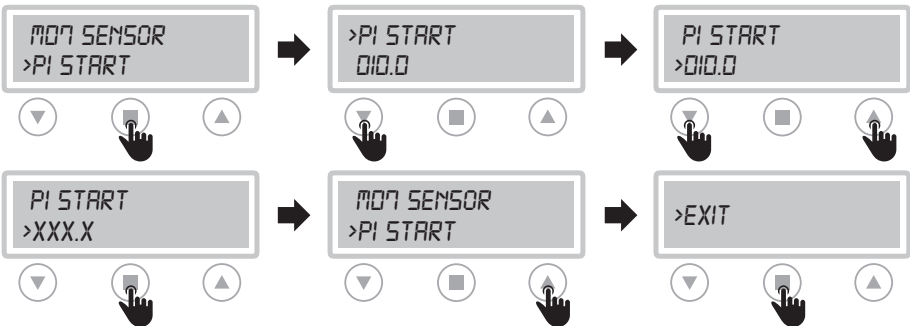

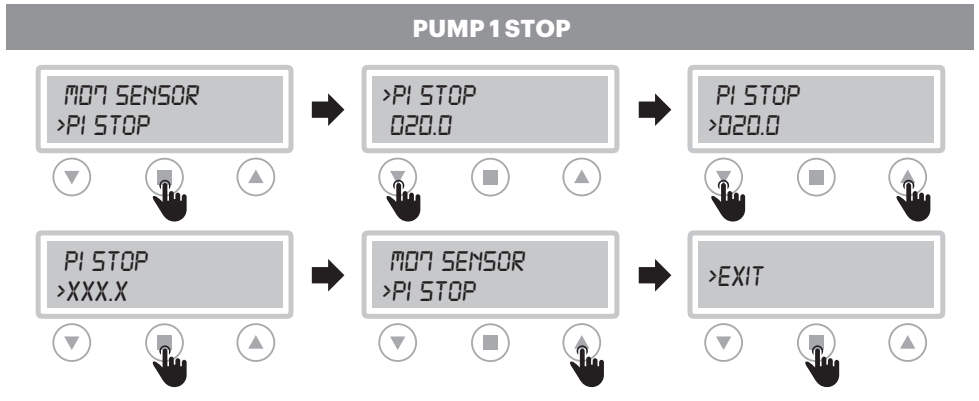

IMPORTANT!

For the mt and celsius parameters you can select the “FILL” and “EMPTY” programs (see page 19)

- **FILL: START value < STOP value**
- **EMPTY: START value > STOP value**

For the bar parameter can be selected only the “EMPTY” program

- **EMPTY: START value < STOP value**

MOB TIMER

ACCESS TO FUNCTION	MODIFIED PARAMETERS
 <p>MOB SENSOR >MOB TIMER</p> <p>Navigation icons: Down arrow, Square button, Up arrow. A hand icon is shown pressing the square button.</p>	<p>ENGAGE TIMER T1 (default: OFF) TIMER T1 ON 0-720min (default is 0min.) Setting the working minutes of the pump TIMER T1 OFF 1-1440min (default is 0min) Setting the pause minutes of the pump</p>

SET DUTY/STAND-BY

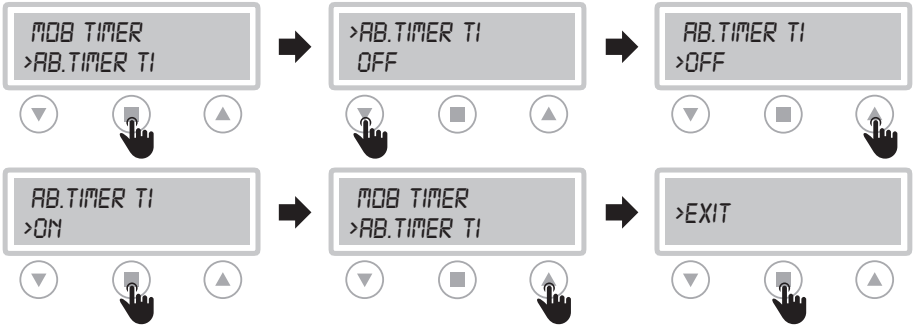

TIMER T1 ON

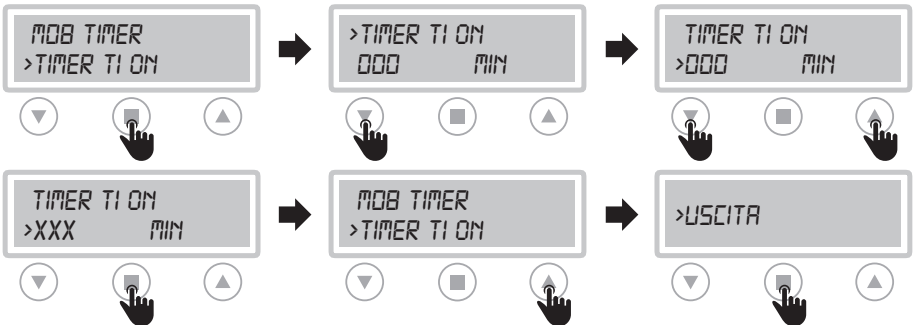

TIMER T1 OFF

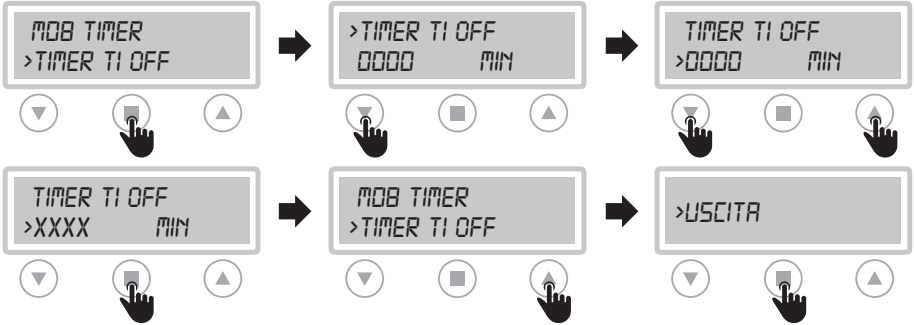

TRIMMER SETTINGS

To change manually the threshold for protection, **interrupt the power supply to the control panel** working on the trimmers. Please follow the below instructions:



PROTECTION DELAY

The pump protection switching delay has been set at **5 sec**

TRIMMER SETTING

TRIMMER 1: PROBE SENSITIVITY CHANGE

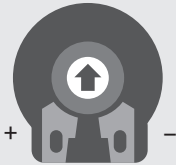

Probe sensitivity (CLC) and water in oil chamber sensor trimmer regulation.

It is possible to change the sensitivity of the CLC probes and the water sensor in the oil chamber **interrupting the power supply to the control panel** and acting on trimmer 1 (clockwise to increase and counterclockwise to decrease sensitivity).

ALARM CONTACT OUTPUTS

SINGLE PHASE VERSION

Alarm outputs:

- L-OUT / N = 230 VAC
- + -12 / NO = 12V d.c. or contact NO

THREE PHASE VERSION

Alarm outputs:

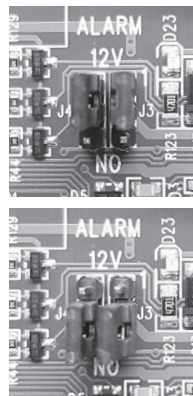
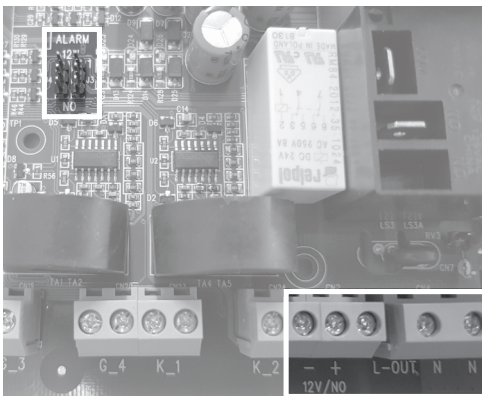

- L-OUT / N = 400 VAC
- + -12 / NO = 12V d.c. or contact NO



12 V d.c. output

free contact NO

PUMPS STOP

MODE	BUTTON	STOP
MANUAL		The motor stops when the “MANUAL” button is released or once you press the 0 button.
AUTOMATIC		When the input commands are disable/non active once you digit the 0 button.
OFF		Turn the main switch in the interlocking door to “OFF” position.

SERVICE

SwitchGenie does not require any routine maintenance provided that its working limits are observed. Any maintenance operations must be performed by qualified and experienced personnel, in compliance with the safety regulations in force.



DANGER!

Make sure that SwitchGenie is disconnected from the power supply before performing any maintenance operations.

SPARE PARTS

Always state the exact model identification number when requesting technical information or spare parts from our sales and service centre.

Use only original spare parts when replacing any faulty components. The use of unsuitable spare parts can cause malfunctions, personal injury and damage to property.

WASTE DISPOSAL

After the control panel has been installed and started, the customer must provide for the appropriate elimination/disposal of the waste materials according to the legislation locally in force. If the control panel or parts of it must be taken out of service and dismantled, follow local regulations regarding sorted waste disposal. Refer to the appropriate recycling centres.



CAUTION!

Contamination of the environment with hazardous substances such as battery acid, fuel, oil, plastic, copper, etc., may cause serious damage to the environment and endanger people’s health.

CERTIFICATE OF CONFORMITY

SWITCHGENIE SINGLE and DUAL models

**ARE IN CONFORMITY
WITH COMMUNITY DIRECTIVES REGARDING:**

- European directive 2006/95/CE
- Electromagnetic compatibility directive 2004/108/CE



AND AS APPLICABLE TO HARMONIZED STANDARDS:

- EN 61439-1
- EN 61439-2
- EN 60204-1
- EN 55014-1
- EN 55014-2
- EN 61000-3-2
- EN 61000-3-3

.....

.....

.....

.....

.....

.....

.....

.....

.....

.....

.....

.....

.....

.....

.....

.....

.....

.....

.....

.....

.....

.....

.....

.....

.....

.....

Warranty Policy for Davies Pump Controllers

Your Davies Pump Controller, when used for its designed purpose should give you years of trouble free service. Please take the time to read and understand the operator's manual for this product before installing and operating. Failure to install and operate as per the operation instructions will render warranty on this unit void.

Davies Pump Controllers are warranted to be free of material and manufacturing defects at the time of purchase. Warranty Period: 2 Years from date of purchase.

This warranty is limited to the cost of the product and does not cover travel charges, removal and re-installation charges, consumables, Electrician or Plumbers charges or any other third party costs unless authorized by Argon Distributors prior to being carried out.

Argon distributors will repair or replace for the consumer any portion of the failed item which has proved to be defective within the warranty period. Replacement product or parts may include refurbished parts or components.

The warranty does not cover Damage or malfunction resulting from:

- A. Misuse, accident, fire, water, lightning, negligence, abuse, product modifications.
- B. Repairs or attempted repairs by unauthorized persons
- C. Damages to product caused by transit
- D. Removal or installation of the product
- E. Normal wear and tear.
- F. Water and Insect ingress
- G. Exposure to corrosive conditions
- H. Foreign objects in the liquid being pumped
- I. Electrical power fluctuations
- J. Freight

Argon Distributors liability is limited to the cost of the product and shall not be liable for:

- A. Damage to other property caused by defects in the product.
 - B. Loss of use of the product.
 - C. Loss of time, loss of profits, loss of business opportunity, loss of goodwill
 - D. Any other damages incidental, consequential or otherwise.
 - E. Claims under this warranty must give evidence of the Date of purchase, Invoice Copy, Model, Serial Number, photos and information of the installation as soon as the failure has occurred.
- Owner's detail must be noted.

If any of the above is unclear please contact your supplier or warranty manager at ARGON DISTRIBUTORS.

Proven solutions through experience

ARGON
DISTRIBUTORS LTD



argondistributors.co.nz